

PIEDINI BONE

BONE FEET



- Piedino per moduli base da cucina.
- Compatibile con zoccoli in alluminio e in legno mediante montaggio a vite o con fresata.
- Test effettuati dal CERT - Centro di Certificazione e Test di Treviso Tecnologia.
- Confezionato a 4 pezzi in scatole da 100 pezzi.
- Feet system for kitchen lower cabinets.
- Compatible with the aluminium and wooden plinth through, screw or drilling mounting.
- Tests made by the CERT - Centro Di Certificazione E Test Di Treviso Tecnologia.
- Packaging in bags of 4 units and in boxes of 100 feet.



Usare viti da Ø3,5mm per la base a squadra e da Ø4 o Ø4,5mm tutte le altre.

Use Ø3,5mm screws for angle base and Ø4 or Ø4,5mm for the others.



Piedino Bone 60-80

60-80 Bone foot

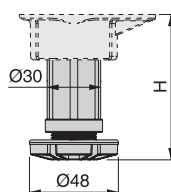

Altezza Zoccolo Height of Plinth	H	Cod.		
60	59 - 75	39113	17	100
80	79 - 95	39114	17	100

Tecnoplastica / Plastic

Piedino Bone 100-180

100-180 Bone foot

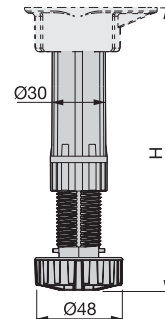

Altezza Zoccolo Height of Plinth	H	Cod.		
100 - 120	98 - 140	39118	17	100
120 - 150	118 - 160	39119	17	100
150 - 165 - 180	148 - 190	39120	17	100

Tecnoplastica / Plastic

Base con montaggio a vite

Screw mounting base

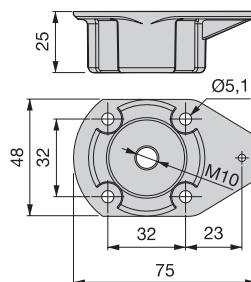

Cod.

39121 17 100

Tecnoplastica / Plastic

Base a montaggio diretto

Direct mounting base

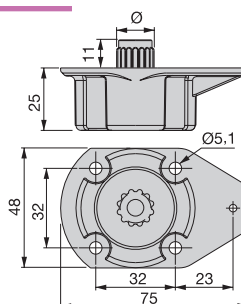

	Ø	Cod.		
12	12,5	39122	17	100
13	13,5	39132	17	100
15	15,5	39131	17	100
16	16,5	39124	17	100

Tecnoplastica / Plastic



Pinza per zoccoli montaggio diretto / vite

Plinth clip. Screw on / Direct Mount

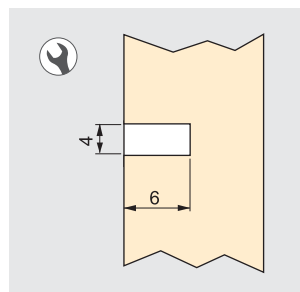
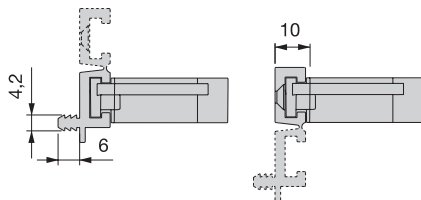

Cod.  

39129 | **17** | 200

Tecnoplastica / Plastic

Pinza per zoccoli Noline e Plasline

Clip for Noline and Plasline plinths

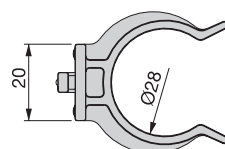
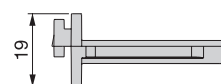

Cod.  

39130 | **17** | 200

Tecnoplastica / Plastic

Vite M10

M10 screw

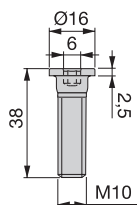

Cod.  

39126 | **05** | 200

Acciaio / Steel

Tappo

Cap

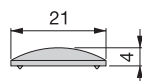

Cod.  



39127 | **15** | 200

Tecnoplastica / Plastic

Kit piede Bone con base

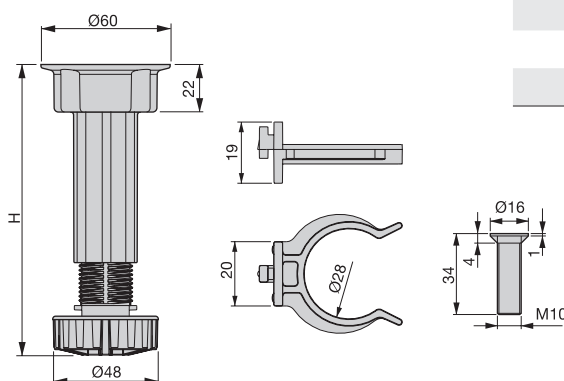
Feet Bone with base kit



Altezza Zoccolo Height of Plinth	H	Cod. 	
100	98 - 115	39995 17	50
120	118 - 135	39990 17	50
150	148 - 165	39994 17	50

Tecnoplastica / Plastic

ZOCCOLI E ACCESSORI NOLINE*NOLINE PLINTHS AND ACCESSORIES*

- Compatibile con i piedini Bone.
- *Compatible with Bone feet.*

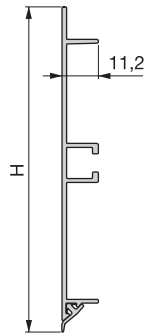
Zoccolo Noline*Noline plinth*

H	L	Cod.		
60	4 m	80417	63	24 m
80	4 m	80418	63	24 m
100	4 m	80411	63	24 m
120	4 m	80420	63	24 m
150	4 m	80421	63	24 m
165	4 m	80422	63	24 m

Alluminio / Aluminium



Angolo da 90°

90° angle



H	Cod.		
100	80583	62	20
120	80584	62	20
150	80795	62	20
165	80050	62	20

Alluminio / Aluminium

Prolunga

Extension

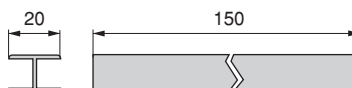

Cod.		
80793	62	20

Alluminio / Aluminium

Angolo regolabile

Adjustable angle

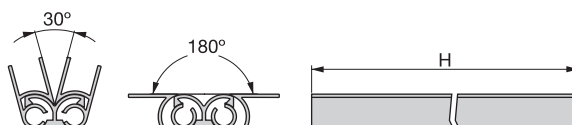

H	Cod.		
60	80534	62	10
80	80537	62	10
100	80587	62	10
120	81588	62	10
150	80945	62	10
165	80053	62	10

Alluminio / Aluminium

ZOCCOLI E ACCESSORI PLASLINE

PLASLINES PLINTHS AND ACCESSORIES



- Compatibile con i piedini Bone.
- Vengono forniti con un film di protezione.
- I pezzi con finitura 15 constano di rivestimento di carta bianca sopra la struttura in plastica.
- *Compatible with Bone feet.*
- *Supplied with protective plastic film.*
- *Pieces with finish n° 15 have a white aluminium laminate covering the plastic structure.*

Zoccolo Plasline

Plasline plinth

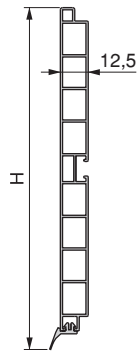

H	L		Cod.			
100	2,4 m	80604	-	63	69	24 m
100	4 m	80601	-	63	69	40 m
120	4 m	80602	-	63	-	40 m
150	2,4 m	80605	-	63	69	24 m
150	4 m	80603	15	63	69	40 m
165	4 m	80610	-	63	-	40 m
180	4 m	89130	-	63	-	40 m

Alluminio e tecnoplastica / Aluminium and plastic





- Pezzi con rifinitura 15 consistono di rivestimento di carta bianca sopra la struttura in plastica.

- The parts with finish code 15 consist of a plastic structure covered in a thin white melamine sheet.

Angolo da 90°

90° angle

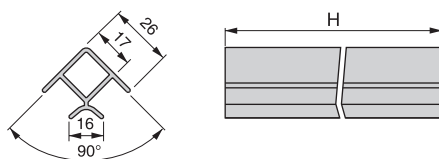

H	Cod.			
100	80116	63	69	20
120	80135	63	-	20
150	80156	63	69	20
165	89194	63	-	20
180	89131	63	-	20

Alluminio e tecnoplastica
 Aluminium and plastic

- La parte interna è rivestita.
- Interior coated side.

Prolunga

Extension



H	Cod.			
150	80609	63	-	20

Alluminio e tecnoplastica
 Aluminium and plastic

Prolunga flessibile

Flexible angle

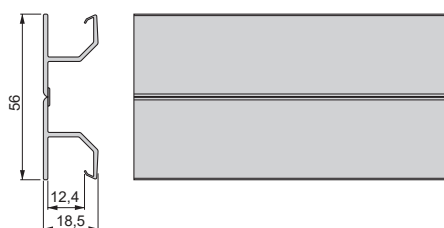

H	Cod.				
100	89101	-	63	69	20
120	89102	-	63	-	20
150	89103	15	63	69	20
165	89104	-	63	-	20
180	89105	-	63	-	20

Tecnoplastica e alluminio
 Plastic and aluminium

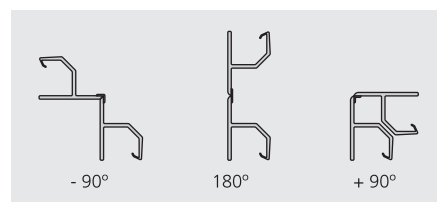

ALZATINE E ACCESSORI**TRIMS AND ACCESSORIES**

- I pezzi con rifinitura 15 consistono di rivestimento di carta bianca sopra la struttura in plastica.

- The parts with finish code 15 consist of a plastic structure covered in a thin white melamine sheet.

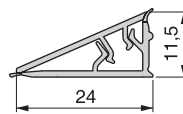
Alzatina Miniline triangolare*Miniline triangular trim*

	Cod.	
4 m	89223 63	40 m

Alluminio e tecnoplastica
Aluminium and plastic

Accessori alzatina Miniline triangolare*Miniline triangular trim accessories*

Cod.	
89224 21	20

Tecnoplastica / Plastic

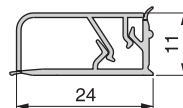
Alzatina Miniline rettangolare*Miniline rectangular trim*

	Cod.	
4 m	89225 63	40 m

Alluminio e tecnoplastica
Aluminium and plastic

Accessori alzatina Miniline rettangolare*Miniline rectangular trim accessories*

Cod.	
89226 21	20

Tecnoplastica / Plastic



Alzatina Plasline

Plasline trim

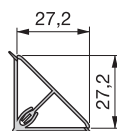

	Cod.	
4 m	89142	63 40 m

Alluminio e tecnoplastica
 Aluminium and plastic

Accessori alzatina Plasline

Plasline trim accessories



Cod.	
89143	21 20

Tecnoplastica / Plastic

Alzatina Mixline

Mixline trim



	Cod.	
4 m	89144	15 63 40 m

Alluminio e tecnoplastica
 Aluminium and plastic

Accessori alzatina Mixline

Mixline trim accessories



Cod.	
89145	15 21 20

Tecnoplastica / Plastic