

JAGMET

Profilo Jagmet cremagliera semplice passo 50mm

Jagmet 50mm single slot profile

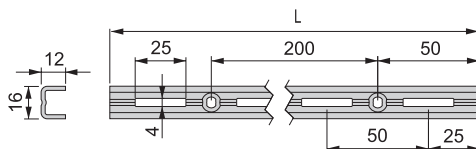

L	Cod.		
1 m	79180	12	10
1,5 m	79164	12	10
2 m	79165	12	10
2,5 m	79166	12	10

Acciaio / Steel

Profilo Jagmet cremagliera doppia passo 32mm

Jagmet 32mm double slot profile

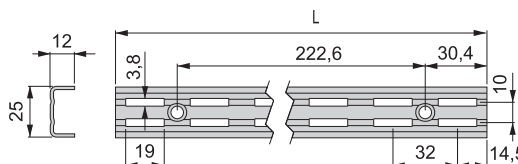

L	Cod.		
0,951 m	79167	12	10
1,396 m	79168	12	10
2,064 m	79169	12	10
2,229 m	79179	12	10

Acciaio / Steel

Reggipiano Jagmet cremagliera semplice passo 50mm

Jagmet 50mm single slot support

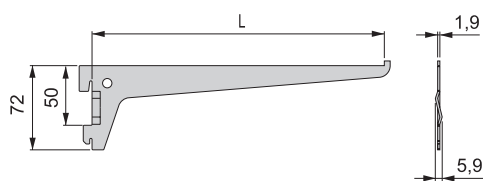

L	Kg	Cod.	
200	40	79170	12 20
250	32	79156	12 20
300	26	79157	12 20
350	23	79158	12 20
400	20	79159	12 20

Acciaio / Steel

Reggipiano Jagmet cremagliera doppia passo 32mm

Jagmet 32mm double slot support

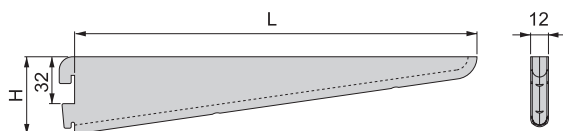

L	H	Kg	Cod.	
170	47	44	79160	12 20
220	49	34	79161	12 20
270	52	27	79162	12 20
320	58	23	79181	12 20
370	64	20	79163	12 20
470	81,9	16	79182	12 20

Acciaio / Steel

SISTEMA TRAM

TRAM STRUCTURE



- Sistema modulare con profili ed accessori.
- Fabbricato in alluminio anodizzato opaco.
- Modular system with profiles and accessories.
- Made in matt anodized aluminium.



Guarda il nostro sito
 View our website
www.emuca.com



TRAM

Profilo Tram

Tram profile

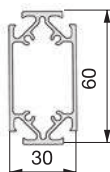

	Cod.	
3 m	61123 62	18 m
Alluminio / Aluminium		

Unione a 2 vie

2-way profile joint



x 4

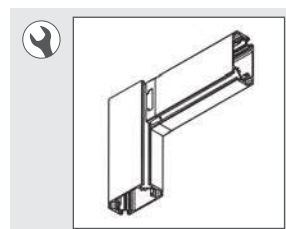
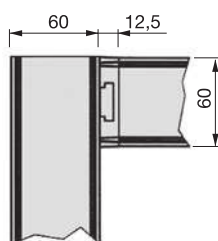

Cod.	
61093 25	1
Zama / Zamak	

Unione a 3 vie

3-way profile joint



x 2

x 2

x 2

x 8

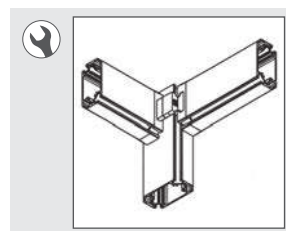
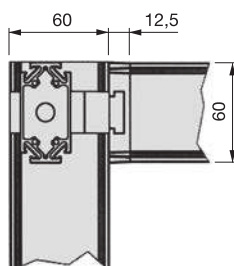

Cod.	
61094 25	1
Zama / Zamak	

Unione a 4 vie

4-way profile joint



x 3

x 2

x 3

x 3

x 12

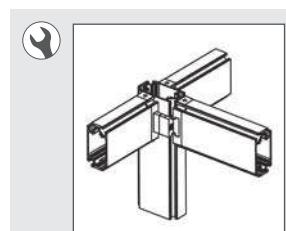
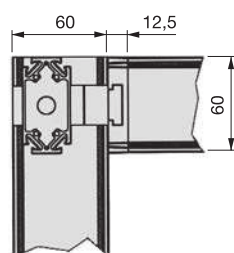

Cod.	
61283 25	1
Zama / Zamak	

TRAM

Regolabile per base e soffitto

Floor / ceiling fixing

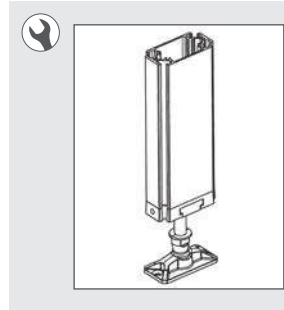
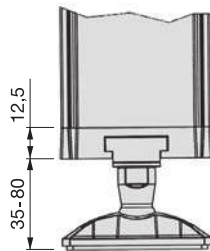

Cod.



61156	25	1
-------	----	---

Tecnoplastica e zama
Plastic e zamak

Fissaggio a muro

Wall fixing

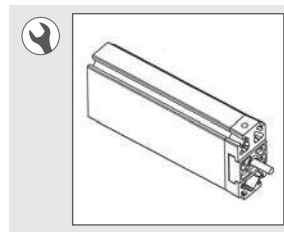
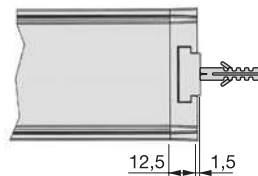

Cod.



61113	25	1
-------	----	---

Zama / Zamak

Tappo di chiusura

Cover



Cod.



61284	21	10
-------	----	----

Tecnoplastica / Plastic



TRAM

Reggipiano per legno

Wood shelf bracket

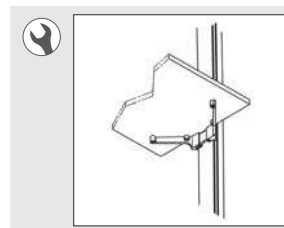

Cod.		
61047	25	1
Zama / Zamak		

Reggipiano per vetro

Glass shelf bracket

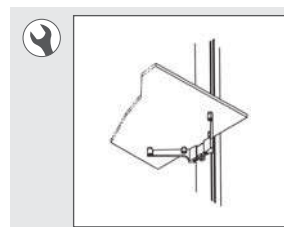

Cod.		
61054	25	1
Zama / Zamak		

- Per vetri da 4 a 10mm.
- For glasses from 4 to 10mm.

Reggipiano inclinabile in legno

Adjustable wooden shelf

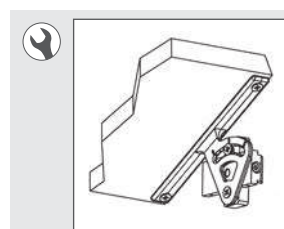
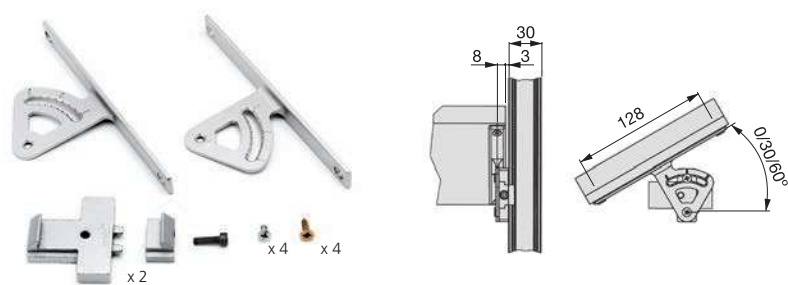

Cod.		
61073	25	1
Zama / Zamak		

Supporto per modulo

Module support

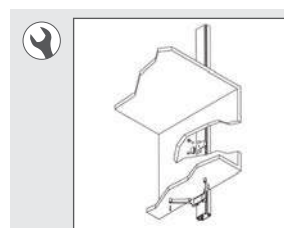

Cod.		
61169	25	1
Zama / Zamak		

TRAM

Supporto reggitubo

Hanging rail support

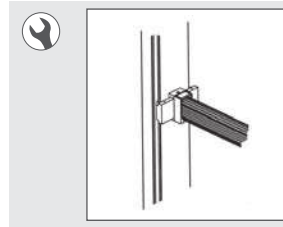
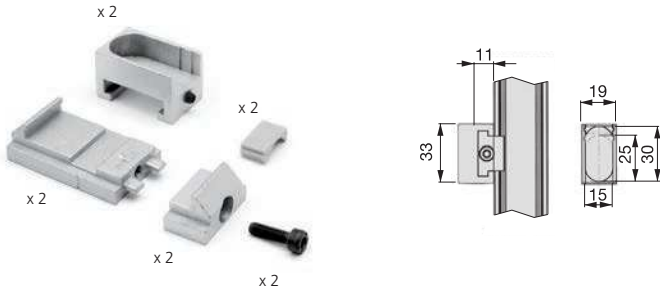

Cod.



61090	25	1
--------------	-----------	----------

Zama / Zamak

Supporto per appendiabiti Hang

Support for Hang wardrobe lift

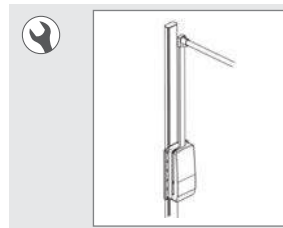

Cod.



61082	25	1
--------------	-----------	----------

Acciaio e zama
Steel and zamak

Profilo passacavi

Cable cover profile

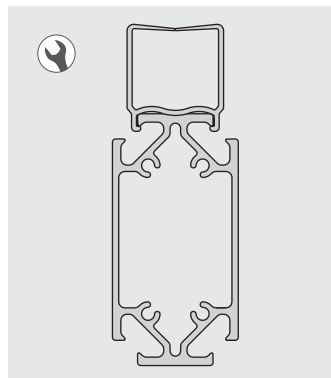
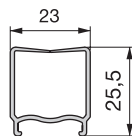

Cod.



2,3 m	69106	21	20,7 m
-------	--------------	-----------	--------

Tecnoplastica / Plastic



INFORMAZIONI / INFORMATION

