

CASSETTO SLIM

SLIM DRAWER

New

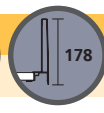
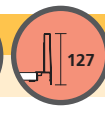
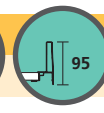
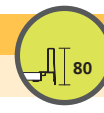

Cassetto esterno Slim 80 mm

Slim exterior drawer 80 mm

KIT

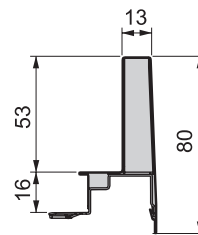

Prof. Depth	Cod.			
450	30262	12	35	1
500	30263	12	35	1

Acciaio / Steel

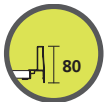

- Il codice include tutti gli elementi per il montaggio di un cassetto esterno ad eccezione del frontale, la schiena ed il fondo.
- Include guide, fianco, coppia di agganci frontali per cassetto esterno e kit agganci posteriori.

- The code includes all the elements for the assembly of an exterior drawer except the front, back and bottom.
- Includes slides, metal sides, kit of front clip for external drawer and set of back fittings for drawer.

Cassetto esterno Slim 95 mm

Slim exterior drawer 95 mm

KIT

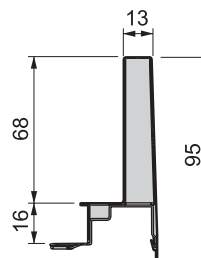

Prof. Depth	Cod.			
300	30264	12	35	1
350	30265	12	35	1
400	30266	12	35	1
450	30267	12	35	1
500	30268	12	35	1

Acciaio / Steel

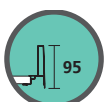

- Il codice include tutti gli elementi per il montaggio di un cassetto esterno ad eccezione del frontale, la schiena ed il fondo.
- Include guide, fianco, coppia di agganci frontali per cassetto esterno e kit agganci posteriori.
- The code includes all the elements for the assembly of an exterior drawer except the front, back and bottom.
- Includes slides, metal sides, kit of front clip for external drawer and set of back fittings for drawer.

CONFIGURATORE
CONFIGURATIONwww.emuca.com

Cassetto esterno Slim 127 mm

Slim exterior drawer 127 mm

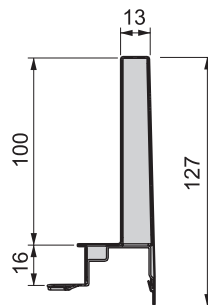

Prof. Depth	Cod.			
300	30269	12	35	1
350	30270	12	35	1
400	30271	12	35	1
450	30272	12	35	1
500	30273	12	35	1

Acciaio / Steel

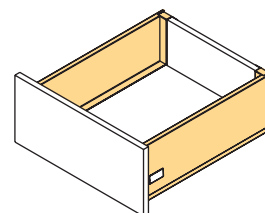

- Il codice include tutti gli elementi per il montaggio di un cassetto esterno ad eccezione del frontale, la schiena ed il fondo.
- Include guide, fianco, coppia di agganci frontali per cassetto esterno e kit agganci posteriori.

- The code includes all the elements for the assembly of an exterior drawer except the front, back and bottom.
- Includes slides, metal sides, kit of front clip for external drawer and set of back fittings for drawer.

Cassetto esterno Slim 178 mm

Slim exterior drawer 178 mm

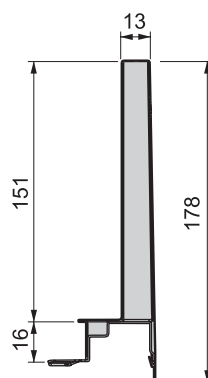

Prof. Depth	Cod.			
350	30275	12	35	1
450	30277	12	35	1
500	30278	12	35	1

Acciaio / Steel

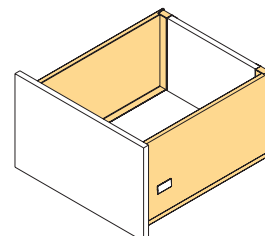

- Il codice include tutti gli elementi per il montaggio di un cassetto esterno ad eccezione del frontale, la schiena ed il fondo.
- Include guide, fianco, coppia di agganci frontali per cassetto esterno e kit agganci posteriori.

- The code includes all the elements for the assembly of an exterior drawer except the front, back and bottom.
- Includes slides, metal sides, kit of front clip for external drawer and set of back fittings for drawer.

YouTube



www.emuca.com

Coppia di agganci frontali 80 mm*Set of frontal fittings 80 mm*

H	Cod.			
80	30251	15	23	4

Tecnoplastica / Plastic

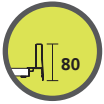
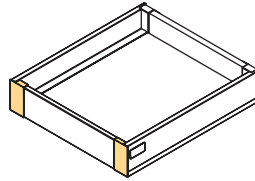
**Coppia di agganci frontali 95 mm***Set of frontal fittings 95 mm*

H	Cod.			
95	30252	15	23	4

Tecnoplastica / Plastic

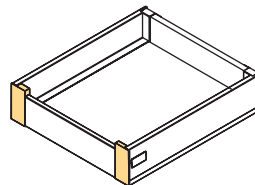
**Coppia di agganci frontali 127 mm***Set of frontal fittings 127 mm*

H	Cod.			
127	30253	15	23	4

Tecnoplastica / Plastic

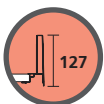
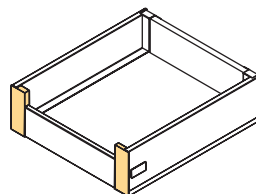

Coppia di agganci frontali 178 mm

Set of frontal fittings 178 mm

H	Cod.			
178	30254	15	23	4
Tecnoplastica / Plastic				

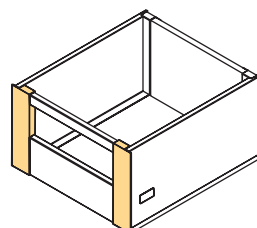

PORTAPOSATE
 CUTLERY TRAYS

8

www.emuca.com

Astina frontale 178 mm

Frontal railing 178 mm

H	L	Cod.		
178	1,1 m	30256	12	35
11 m Acciaio / Steel				

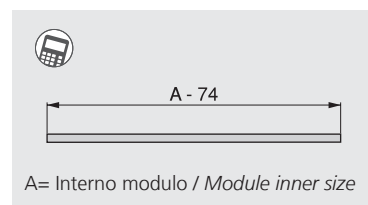
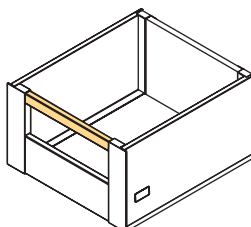

Profilo frontale

Frontal profile

L	Cod.			
1,1 m	30255	12	35	11 m
Alluminio / Aluminium				

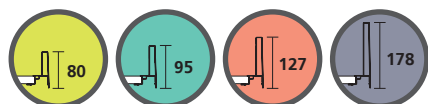
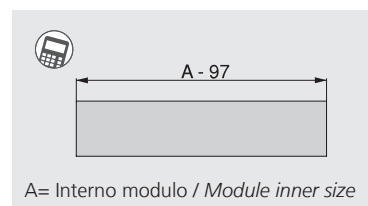
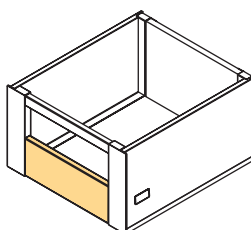
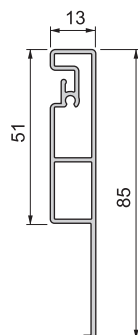

Coppia di astine

Kit of lateral railing

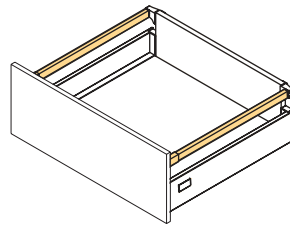

Prof. Depth	Cod.			
300	30279	12	35	20
350	30280	12	35	20
400	30281	12	35	20
450	30282	12	35	20
500	30283	12	35	20

Acciaio / Steel

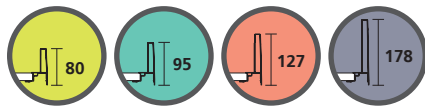

Kit agganci posteriori

Set of back fittings

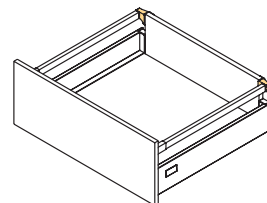

Cod.			
30284	15	23	20

Tecnoplastica / Plastic

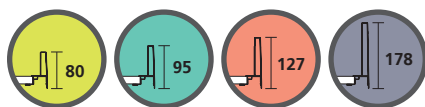

Profilo schiena 95 mm

Back panel profile 95 mm

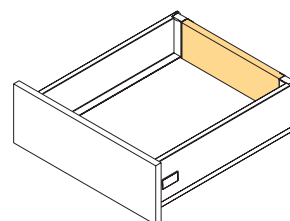
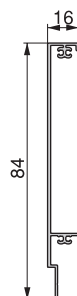

L	Cod.			
1,1 m	30285	12	35	11 m

Alluminio / Aluminium

- Include sacchetto con 80 viti.
- Includes bag with 80 screws.

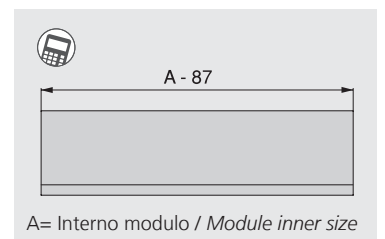

A= Interno modulo / Module inner size



ACCESSORI SLIM

SLIM ACCESSORIES

Set stabilizzatore

Stabilizer set



Prof. Depth	Cod.		
500	41990	21	8

Acciaio, alluminio e tecnoplastica
Steel, aluminium and plastic



Lunghezza della barra stabilizzatrice =
Larghezza interna del modulo - 9 mm.

Stabilizing bar length = module internal
width - 9 mm.

- Sincronizza l'apertura e la chiusura delle guide.
- Stabilizza e evita oscillazioni del cassetto.
- Idoneo per cassetti di larghezza di modulo compreso tra i 900 e i 1200 mm.
- La barra stabilizzatrice può essere tagliata per adattarla alla larghezza del modulo (max. 1200 mm).

- Synchronizes opening and closing of drawer slides.
- Stabilizes action to avoid sideways movement of drawers.
- Ideal for drawers from 900 to 1200 mm wide.
- Stabilizing bar can be cut to fit module width (maximum 1200 mm).

Distanziale laterale

Lateral spacers

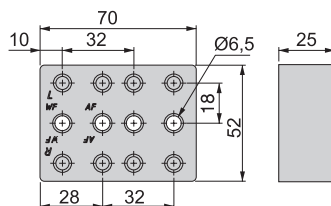
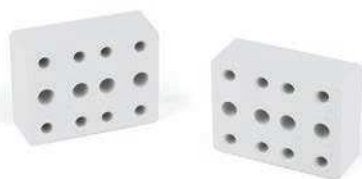

Cod.

41941	15	8
-------	----	---

Tecnoplastica / Plastic

- Permette di montaggio con porte incernierate.
- Allows assembly with hinged doors.



Per il montaggio della guida si raccomanda l'utilizzo di viti Euro.

For the assembly, we recommend to use Euro screws.



Unione frontalino-fondo Lokbox

Lokbox front-bottom union



Cod.



30026	21	20
--------------	-----------	-----------

Tecnoplastica / Plastic

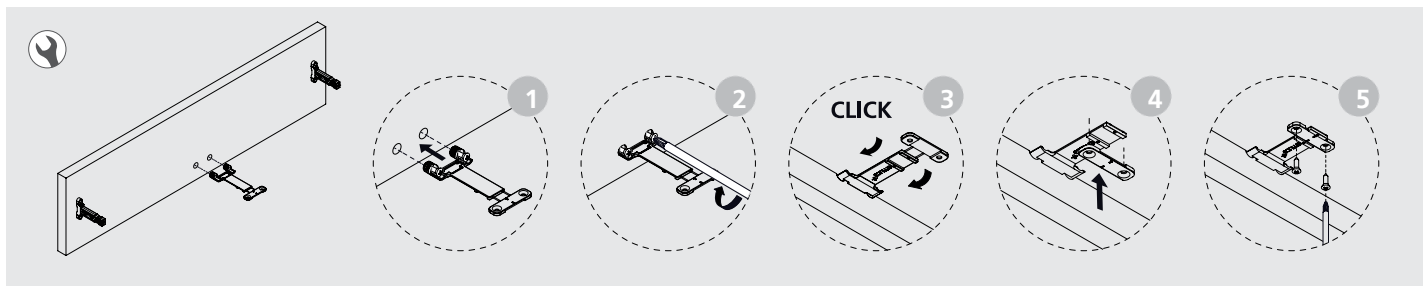
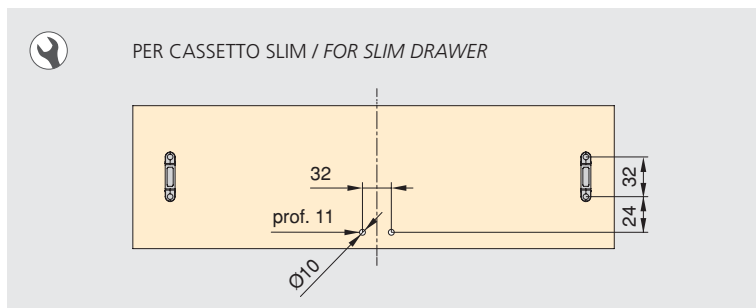

YouTube



www.emuca.com

Salva sifone rettangolare con vaschetta

Rectangular under-sink insert



Cod.		
30114	15	23
		6
Tecnoplastica / Plastic		

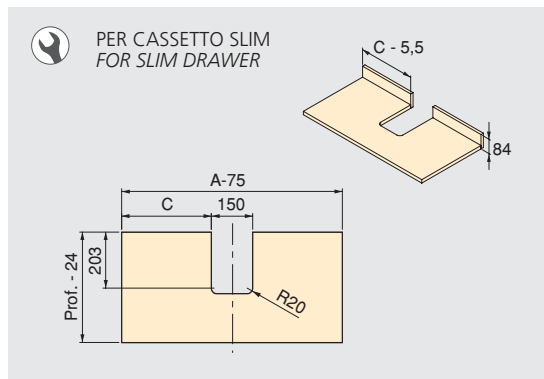
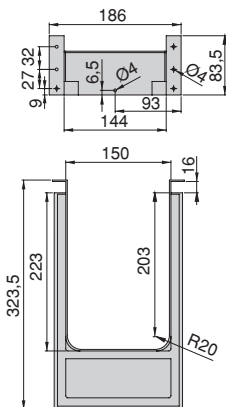

Schiena curva sagomata in plastica

Curved-undersink-insert

Cod.		
30121	15	10
30115	15	80
Tecnoplastica / Plastic		

