

ACCESSORI

ACCESSORIES

Cuneo 5°

5° wedge



- Utilizzabili con basette per cerniere C91, X91, C95, X95, C90 e C10.
- Non compatibili con basette con regolazione eccentrica C91 e X91.

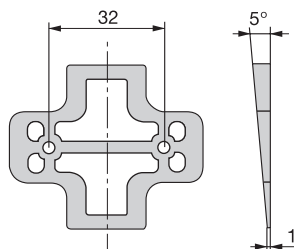

Cod.



11649 15 200

Tecnoplastica / Plastic

- Compatible with screw plates for the C91, X91, C95, X95, C90 and C10 hinges.
- Not compatible with plates with eccentric regulation C91 and X91.

Cuneo 10°

10° wedge



- Utilizzabili con basette per cerniere C91, X91, C95, X95, C90 e C10.
- Non compatibili con basette con regolazione eccentrica C91 e X91.

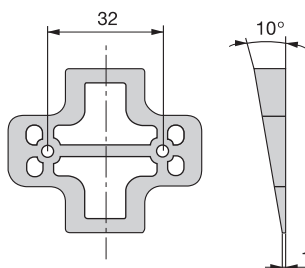

Cod.



11634 15 200

Tecnoplastica / Plastic

- Compatible with screw plates for the C91, X91, C95, X95, C90 and C10 hinges.
- Not compatible with plates with eccentric regulation C91 and X91.

Distanziale

Spacer



- Utilizzabili con basette per cerniere C91, X91, C95, X95, C90 e C10.
- Non compatibili con basette con regolazione eccentrica C91 e X91.

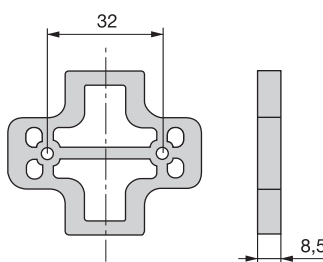

Cod.



11650 15 200

Tecnoplastica / Plastic

- Compatible with screw plates for the C91, X91, C95, X95, C90 and C10 hinges.
- Not compatible with plates with eccentric regulation C91 and X91.

Piastra braccio acciaio

Steel cover plate



- Utilizzabili con cerniere C91, X91, C95, X95 e C90 eccetto quelle da 165°.
- Piastre estetiche si possono personalizzare. Richiedere condizioni.

- Compatible with C91, X91, C95, X95 and C90 hinges except those of 165°.
- Consult conditions for personalization.

Cod.





12397 07 1000

Acciaio / Steel

Piastra per scodellino Ø35

Steel cover plate



Cod. 	
19077 07	1.000
Acciaio / Steel	



• Utilizzabili con cerniere C91 con scodellino Ø35, eccetto quelle C91 da 155°.

• Compatible with C91 hinges with Ø35 cup, except those C91 of 155°.

Vite

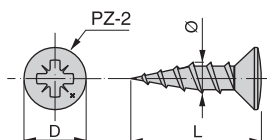
Raised head screw





D	Ø	L	Cod. 	
7,9	4	15	50009 07	500
6,5	3,5	16	50008 07	500
Acciaio / Steel				

Vite testa piana Ø4 x 16

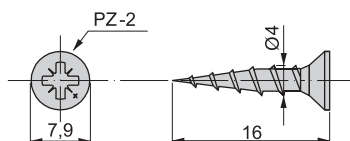
Flat head Ø4x16 screw





Cod. 	
50323 05	1.000
Acciaio / Steel	

Vite testa extrapiana

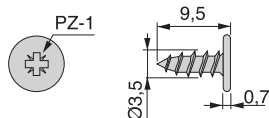
Extra flat head screw



Cod. 	
61813 07	1.000
Acciaio / Steel	



Per cerniera con profilo alluminio.
For hinges with aluminium profiles.

CHIUSURE AMMORTIZZATORI

SPRING LATCHES

Mildy con base diritta

Mildy with straight-edged base

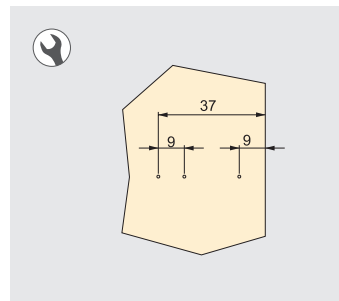
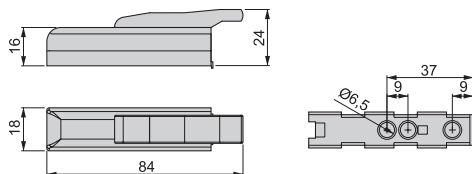
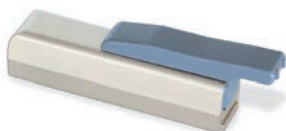

Cod.



12609 24 200

Tecnoplastica / Plastic

Mildy con base a croce

Mildy with a cross-piece

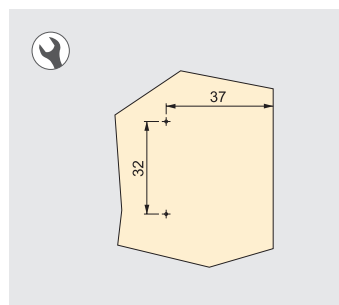
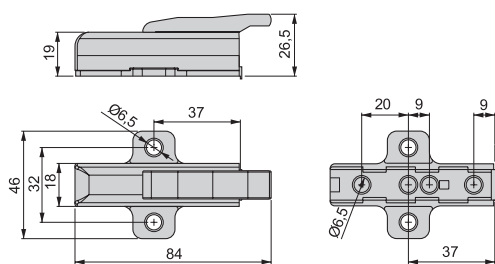

Cod.



12610 24 200

Tecnoplastica / Plastic

Pistone ammortizzatore Minidamp 3 con regolazione corsa

Minidamp 3 piston damper with adjustable run

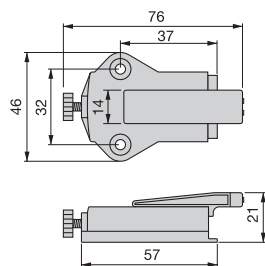

Cod.



12659 21 200

Tecnoplastica / Plastic

Pistone ammortizzatore Minidamp 2

Minidamp 2 piston damper

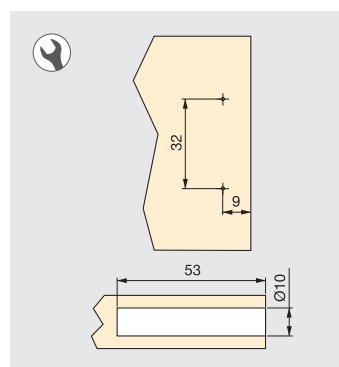
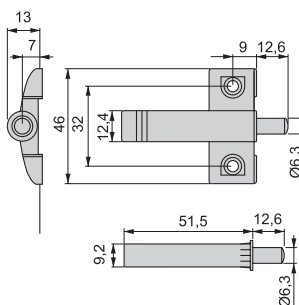

Cod.



12657 21 100

Tecnoplastica / Plastic

