

## VITI METRICHE

## METRIC SCREWS

## Vite M6

M6 screw

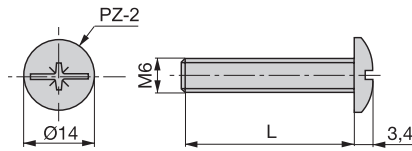

L	Cod.		
14	50564	07	2.000
20	50221	07	2.000
25	50565	07	2.000
30	70501	07	2.000
35	60942	07	2.000
40	51320	07	1.000
50	51321	07	1.000
60	51322	07	1.000

Acciaio / Steel

## Vite unione femmina M6

M6 bolt

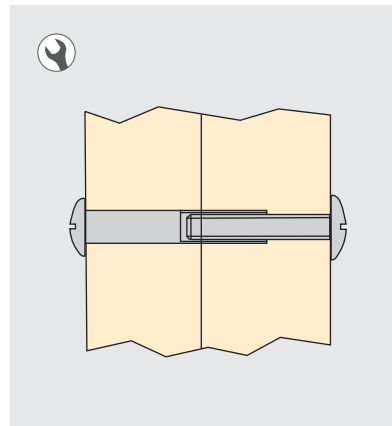
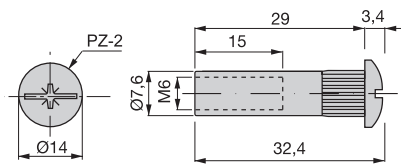

Cod.

50213 07 2.000

Acciaio / Steel

## Tubetto M6

M6 sheath

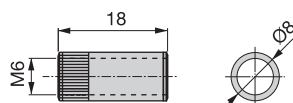

Cod.

90197 02 2.000

Ottone / Brass



**Vite M4**

M4 screw

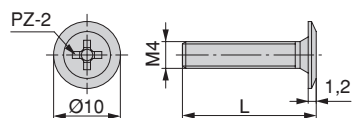

L	Cod.		
8	41300	07	2.000
10	41301	07	2.000
14	41302	07	2.000
20	41303	07	2.000
22	41304	07	2.000
25	41305	07	2.000
30	41306	07	2.000
35	41307	07	2.000
40	41308	07	2.000

Acciaio / Steel

**Vite unione femmina M4**

M4 bolt

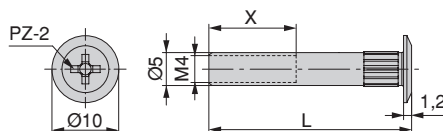

L	X	Cod.		
15	9	41309	07	2.000
29	13	41310	07	2.000

Acciaio / Steel

**Tubetto M4**

M4 sheath

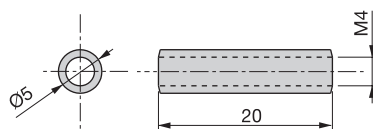

Cod.		
90203	02	2.000

Ottone / Brass

**Set 2 viti + 2 bussole**

Set 2 screws + 2 bolts



Cod.		
41311	07	500

Acciaio / Steel



Ogni set contiene:  
2 viti Cod. 4130207  
2 bussole Cod. 4131007

Each set contains:  
2 screws Cod. 4130207  
2 bolts Cod. 4131007

## VITI EURO

## EURO SCREWS

## Vite euro TSP

Flathead euro screw

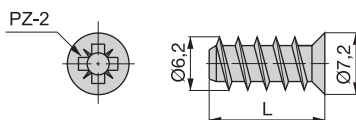

L	Cod.			
11	61085	05	07	1.000
13	51237	05	07	1.000

Acciaio / Steel

- Viti per foro Ø5mm.
- For Ø5mm hole.

## Vite euro TSP passo stretto

Fine thread flathead euro screw

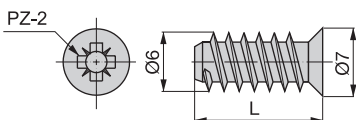

L	Cod.			
12	80670	05	-	2.000
13,7	50441	05	07	2.000
17	50440	05	07	2.000

Acciaio / Steel

- Viti per foro Ø5mm.
- For Ø5mm hole.

## Vite euro TC passo stretto

Roundhead fine thread euro screw

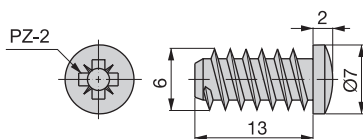

Cod.			
82341	05	07	2.000

Acciaio / Steel

- Viti per foro Ø5mm.
- For Ø5mm hole.

## VITI DIRETTE PER CHIAVE ESAGONALE

## SELF-TAPPING ALLEN SCREWS

## Vite diretta Ø7

Ø7 screw

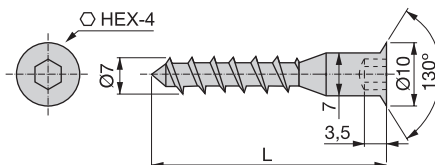

L	Cod.				
50	70121	05	06	09	2.000
60	70507	-	-	09	1.000
70	70138	-	-	09	1.000

Acciaio / Steel

- Viti per foro Ø5mm.
- For Ø5mm hole.

## Vite diretta Ø5

Ø5 screw

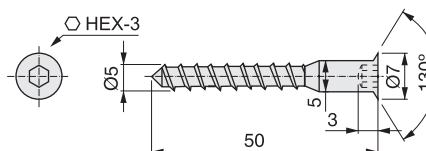

Cod.			
70119	05	09	3.000

Acciaio / Steel

- Viti per foro Ø3mm.
- For Ø3mm hole.

05 | Zincato bianco  
Zinc plated06 | Tropicalizzato  
Zinc dichromate07 | Nichelato  
Nickel plated09 | Zincato nero  
Black zinc plated

## VITI TSP POZIDRIVE AUTOFILETTANTI

### SELF-TAPPING POZIDRIVE SCREWS

#### Vite TSP VBA plus

Flathead VBA Plus screw

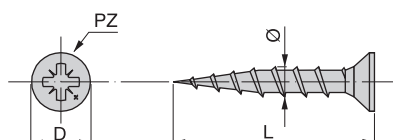

Ø	L	Cod.			
2,5	15	50302	-	06	1.000
3	12	50306	-	06	500
3	15	50307	-	06	500
3	20	50308	-	06	500
3	25	50309	-	06	500
3	30	50310	-	06	500
3,5	15	50314	05	-	500
3,5	20	50395	05	-	500
3,5	25	50316	-	06	500
3,5	30	50317	-	06	500
3,5	35	50318	-	06	500
3,5	40	50319	05	-	500
4	15	50323	05	-	500
4	20	50324	05	-	500
4	25	50325	05	-	500
4	30	50326	05	-	500
4	35	50327	05	-	500
4	40	50328	05	-	500
4	50	50330	05	-	500
4	60	50331	05	-	500
4,5	50	50338	05	-	500
4,5	60	50339	05	-	500
5	50	50396	05	-	500

Acciaio / Steel



Ø	PZ	D
2,5	1	5,1
3		5,9
3,5	2	6,9
4		7,9
4,5		8,9
5		9,9

#### Vite TSP VBA plus filetto parziale

Partially-threaded flathead VBA Plus screw

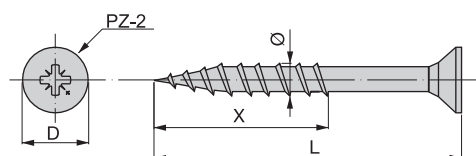

Ø	L	X	Cod.		
3,5	50	30	50393	-	06
4,5	70	44	50352	05	-

Acciaio / Steel



Ø	PZ	D
3,5	2	6,9
4,5		8,9

**Vite TC VBA plus**

Roundhead VBA screw

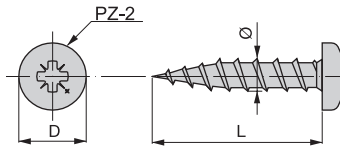

Ø	L	Cod.		
3,5	15	<b>50372</b>	<b>05</b>	500
4	10	<b>50375</b>	<b>05</b>	500
4,5	17	<b>50379</b>	<b>05</b>	500

Acciaio / Steel



Ø	PZ	D
4		8
3,5	2	7
4,5		9

**Vite VBA Plus testa piana larga**

Wide extra flathead VBA Plus screw

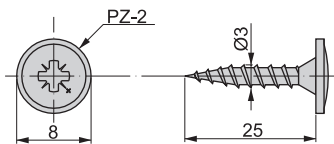

Cod.

<b>50369</b>	<b>05</b>	500
--------------	-----------	-----

Acciaio / Steel

**Vite TGS VBA plus**

Raised-head VBA Plus screw

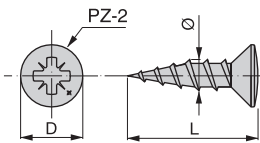

D	Ø	L	Cod.		
7,9	4	15	<b>50009</b>	<b>07</b>	500
6,5	3,5	16	<b>50008</b>	<b>07</b>	500

Acciaio / Steel

**Vite XZ**

XZ screw

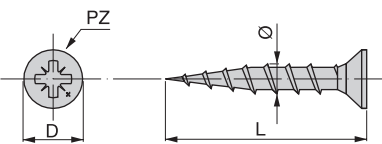

Ø	L	Cod.		
3	16	<b>82177</b>	<b>05</b>	1.000
3,5	16	<b>53901</b>	<b>05</b>	1.000
3,5	20	<b>53904</b>	<b>05</b>	1.000
3,5	30	<b>80240</b>	<b>05</b>	500
4	16	<b>53907</b>	<b>05</b>	500
4	20	<b>82186</b>	<b>05</b>	500
4	30	<b>81067</b>	<b>05</b>	500

Acciaio / Steel



Ø	PZ	D
3	1	5,8
3,5	2	6,7
4	2	7,7

03 | Acciaio grezzo  
Natural steel05 | Zincato bianco  
Zinc plated07 | Nichelato  
Nickel plated

## PUNTE, PORTAPUNTE E CHIAVI ESAGONALI

*BITS, BIT HOLDERS AND ALLEN KEYS*

### Punta Pozidrive

*Pozidrive bit*

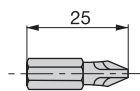

PZ	Cod.		
1	61632	03	5
2	61633	03	5

Acciaio / Steel

### Portapunte magnetico universale

*Universal magnetic bit holder*

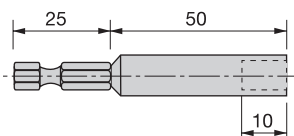

Cod.		
61634	07	1

Acciaio / Steel

### Chiave esagonale a L

*L-shaped allen key*

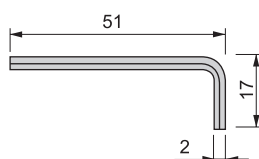

Cod.		
51411	05	1.000

Acciaio / Steel

### Chiave esagonale a Z

*Z-shaped allen key*

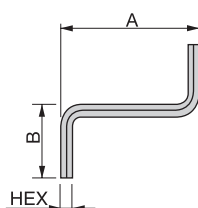

A	B	HEX	Cod.		
35	20	3	60808	05	1.000
46	22	4	60626	05	1.000

Acciaio / Steel

## BUSSOLE

## SOCKETS

## Fondello ragno

Pronged

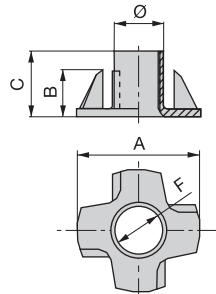

A	B	C	Ø	F	Cod.		
17	6,5	8	8	M6	<b>30070</b>	<b>05</b>	1.000
19	6	8	9	M8	<b>30069</b>	<b>05</b>	1.000
22,5	7,5	11	12	M10	<b>30068</b>	<b>05</b>	1.000

Acciaio / Steel

## Fondello da avvitare

Screw-in

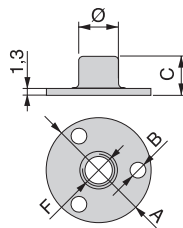

A	B	C	Ø	F	Cod.		
25	3,5	12,3	10	M8	<b>50447</b>	<b>05</b>	1.250
29	3,8	11,3	11,6	M10	<b>50446</b>	<b>05</b>	1.250

Acciaio / Steel

## Fondello a pressione

Wide rimmed

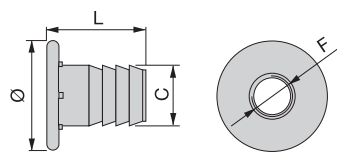

L	Ø	C	D	F	Cod.		
15,4	13,6	8,7	8	M6	<b>80667</b>	<b>05</b>	1.000
18	20	10,7	10	M8	<b>80291</b>	<b>05</b>	1.000
19	22	12,5	12	M10	<b>80353</b>	<b>05</b>	1.000

Acciaio / Steel

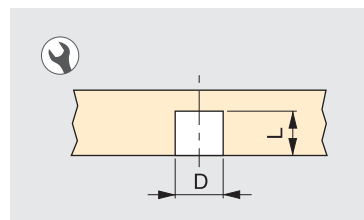

ALTRI PRODOTTI CHE POTREBBERO INTERESSARTI  
OTHER PRODUCTS THAT MAY INTEREST YOU



pag. 4.08



pag. 4.13



pag. 4.18



pag. 4.22



**Bussola ad espansione**

Expanding socket

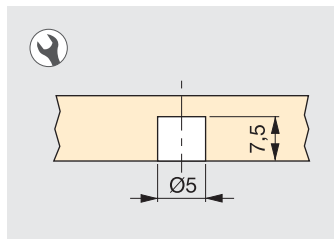
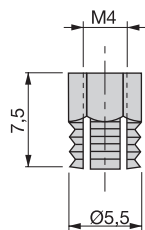

Cod.



90034 02 1.000

Ottone / Brass

**Bussola ad espansione**

Expanding socket

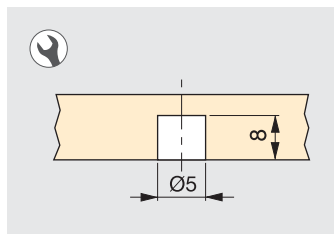
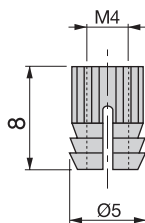

Cod.



90033 02 5.000

Ottone / Brass

**Bussola ad espansione**

Expanding socket

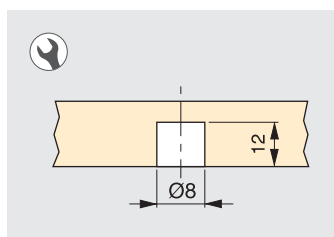
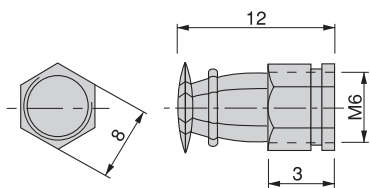

Cod.



80082 02 2.500

Ottone / Brass

- Con sfera interna per espansione.
- With expanding ball.





**Bussola esagono incassato**

Hexagonal built-in socket



F	D	E	T	L	Ø	Cod.			
M6	8	6	12	10	9,5	<b>80280</b>	<b>01</b>	<b>05</b>	1.000
M6	8	6	12	13	10,5	<b>80080</b>	<b>01</b>	<b>05</b>	5.000
M6	8	6	12	18	10,5	<b>80077</b>	<b>01</b>	<b>05</b>	1.000
M8	10	8	14	15	12	<b>80076</b>	<b>01</b>	<b>05</b>	1.000

Zama / Zamak

F	D	E	T	L	Ø	Cod.			
M6	8	6	11,5	23,5	9,5	<b>94077</b>	<b>05</b>		1.000

Acciaio / Steel

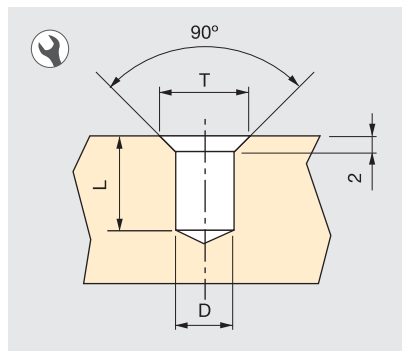
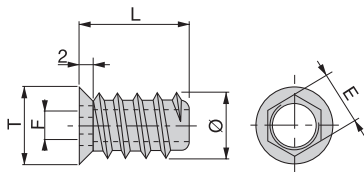
**Bussola M4**

M4 socket

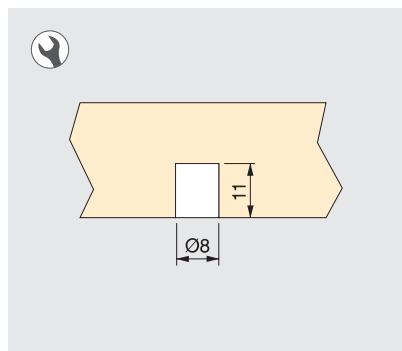
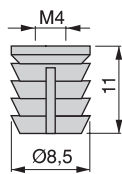

Cod.

**90474** **20** 2.000

Tecnoplastica / Plastic

**Bussola M6**

M6 socket

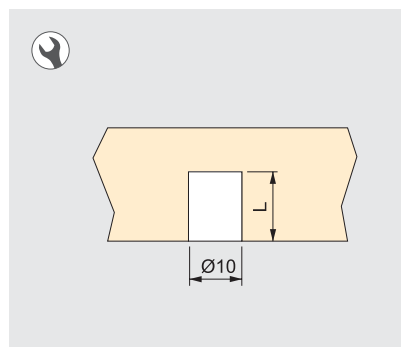
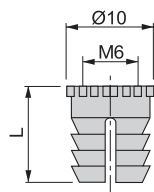

L Cod.

10 **90079** **20** 2.50013 **90078** **20** 2.500

Tecnoplastica / Plastic



**Bussola Ø5**

Ø5 socket

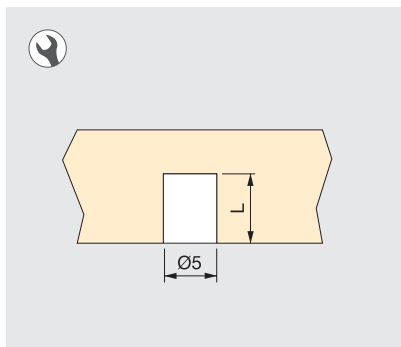
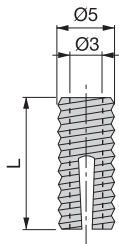

L	Cod.		
10	<b>90409</b>	<b>20</b>	5.000
11	<b>90036</b>	<b>20</b>	5.000

Tecnoplastica / Plastic

**Barilotto**

Housing

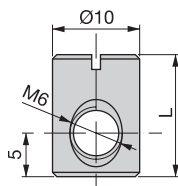

L	Cod.		
12	<b>61089</b>	<b>05</b>	2.000
14	<b>61701</b>	<b>05</b>	2.000

Acciaio / Steel



**PARACOLPI**

*BUMPERS*

**Paracolpi a T**

*T bumpers*

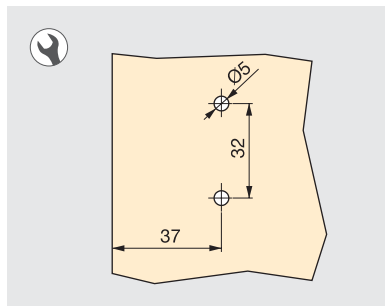
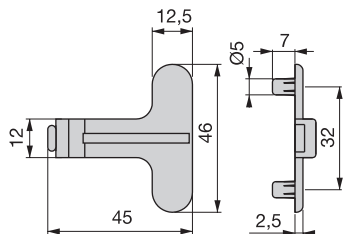

Cod.

<b>90166</b>	<b>20</b>	1.000
--------------	-----------	-------

Tecnoplastica / Plastic

- Battente in plastica morbida
- *Stop in soft plastic.*

**Paracolpi ad incasso**

*Soft-stem*

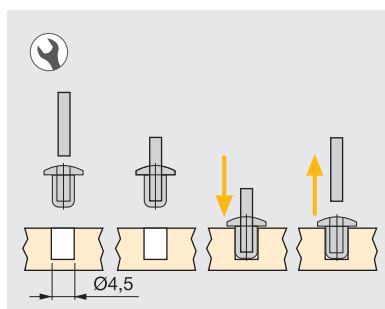
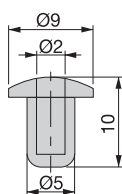

Cod.

<b>90698</b>	<b>20</b>	5.000
--------------	-----------	-------

Tecnoplastica / Plastic

- Non include utensile di montaggio
- *Assembling tool not included.*

**Paracolpi ad incasso**

*Soft-stem*

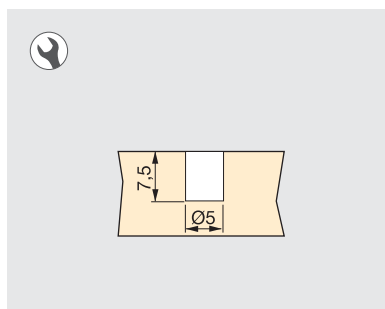
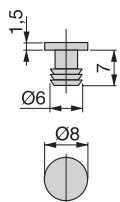

Cod.

<b>90174</b>	<b>15</b>	5.000
--------------	-----------	-------

Tecnoplastica / Plastic

**Paracolpi ad incasso**

*Soft-stem*

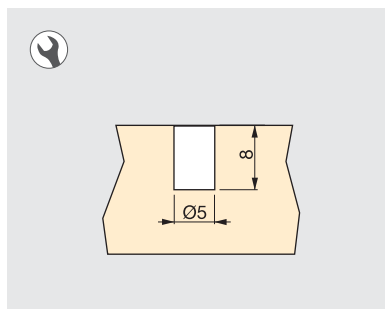
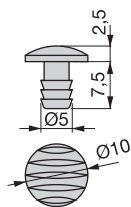

Cod.

<b>90173</b>	<b>20</b>	5.000
--------------	-----------	-------

Tecnoplastica / Plastic

**Paracolpi adesivo**

*Adhesive bumper*

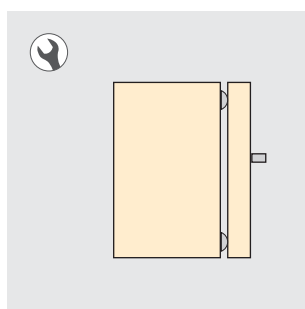
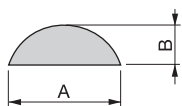

A	B	Cod.		
10	3	<b>30057</b>	<b>20</b>	500
7	1,5	<b>30059</b>	<b>20</b>	500
10	1,5	<b>81710</b>	<b>20</b>	500

Tecnoplastica / Plastic



**COPRIFORI**

COVERCAPS

**Copriforo**

Grooved plastic

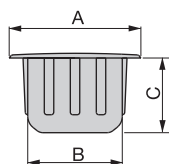

A	B	C	Cod.		
8	5	5	90176	15	1.000
12	8	8	90178	15	1.000

Tecnoplastica / Plastic

**Copriforo adesivo**

Adhesive cap



Ø	N° pezzi N° pieces	Cod.														
13	20 uds / foglio 20 uds / sheet	51289	15	16	17	18	19	21	22	26	27	28	30	50	83	1.000
20	15 uds / foglio 15 uds / sheet	51360	15	16	17	18	19	21	22	26	27	28	30	-	83	900

Tecnoplastica / Plastic



Guardare i nostri cataloghi  
View our catalogues

[www.emuca.com](http://www.emuca.com)

